

WTO

nanoFlex[®]

Das neue Schnellwechsel-Werkzeugsystem
mit sehr kompakter Bauweise und höchster Präzision.

Minimale Investition, maximale Erweiterungsmöglichkeit.



Ideal
für
Langdreher

nanoFlex®

Die optimale Kombination aus ER-Spannzangenaufnahme und modularem Schnellwechselsystem in einem Werkzeughalter.

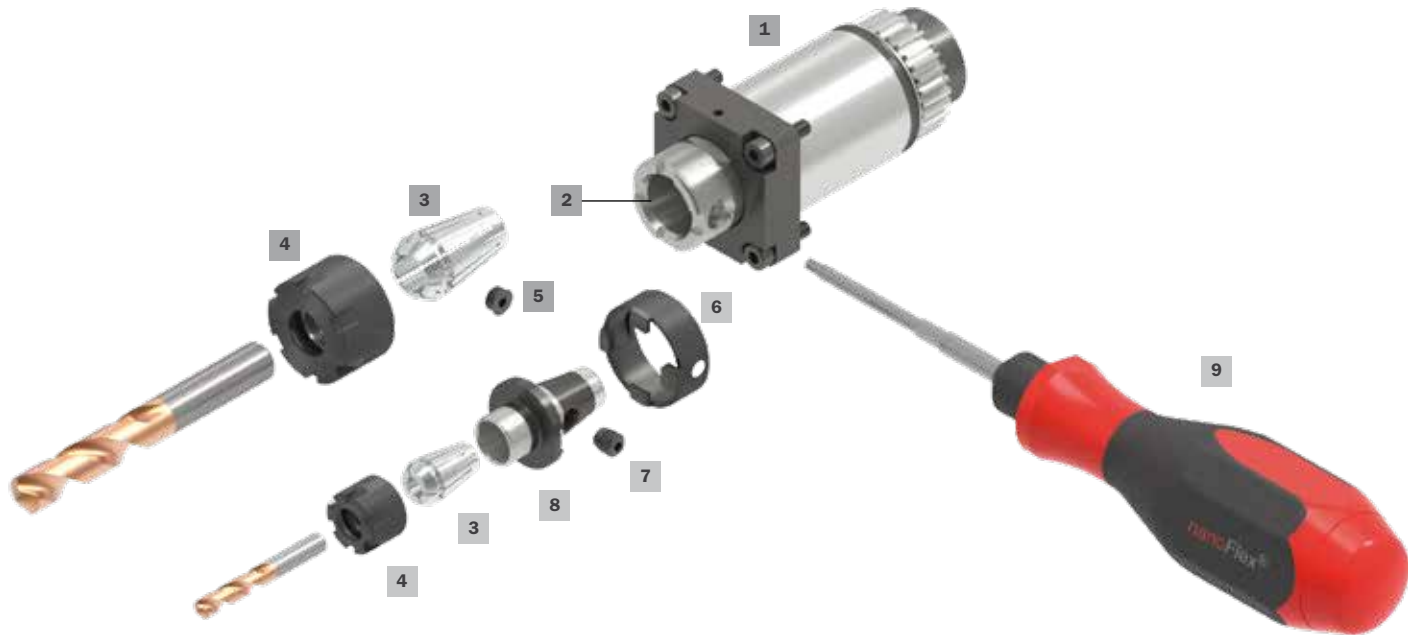

nanoFlex®-Aufnahme vorbereitet für Adapterspannung.

- 1 - Werkzeughalter
- 2 - nanoFlex®-Aufnahme
- 3 - ER-Spannzange
- 4 - Spannzangenmutter
- 5 - Verschlusschraube seitlich
- 6 - Mitnehmerring für Drehmomentmitnahme des nanoFlex®-Adapters
- 7 - nanoFlex®-Spannschraube
- 8 - nanoFlex®-Schnellwechsel-Adapter
- 9 - Einhandbedienschlüssel mit fest eingestelltem Drehmoment zum Spannen und Lösen der nanoFlex®-Schnellwechsel-Adapter
- 10 - Drehmomentmitnahme
- 11 - Kegelaufnahme für ER-Spannzangen und nanoFlex®-Adapter



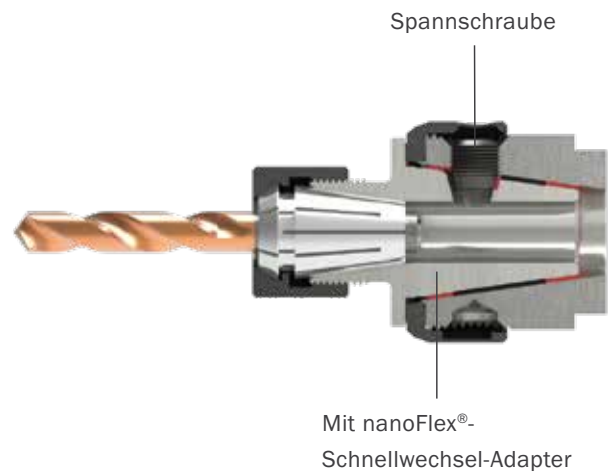
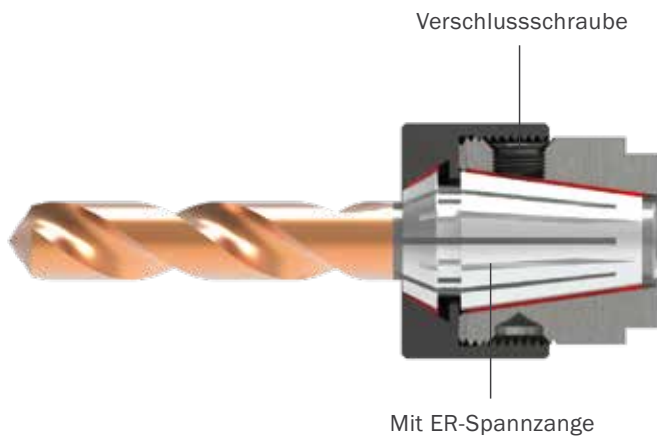

Werkzeugspannung mit Spannzangen.

Werkzeugspannung mit Schnellwechsel-Adapttern.



Handling mit Schnellwechsel-Adapter

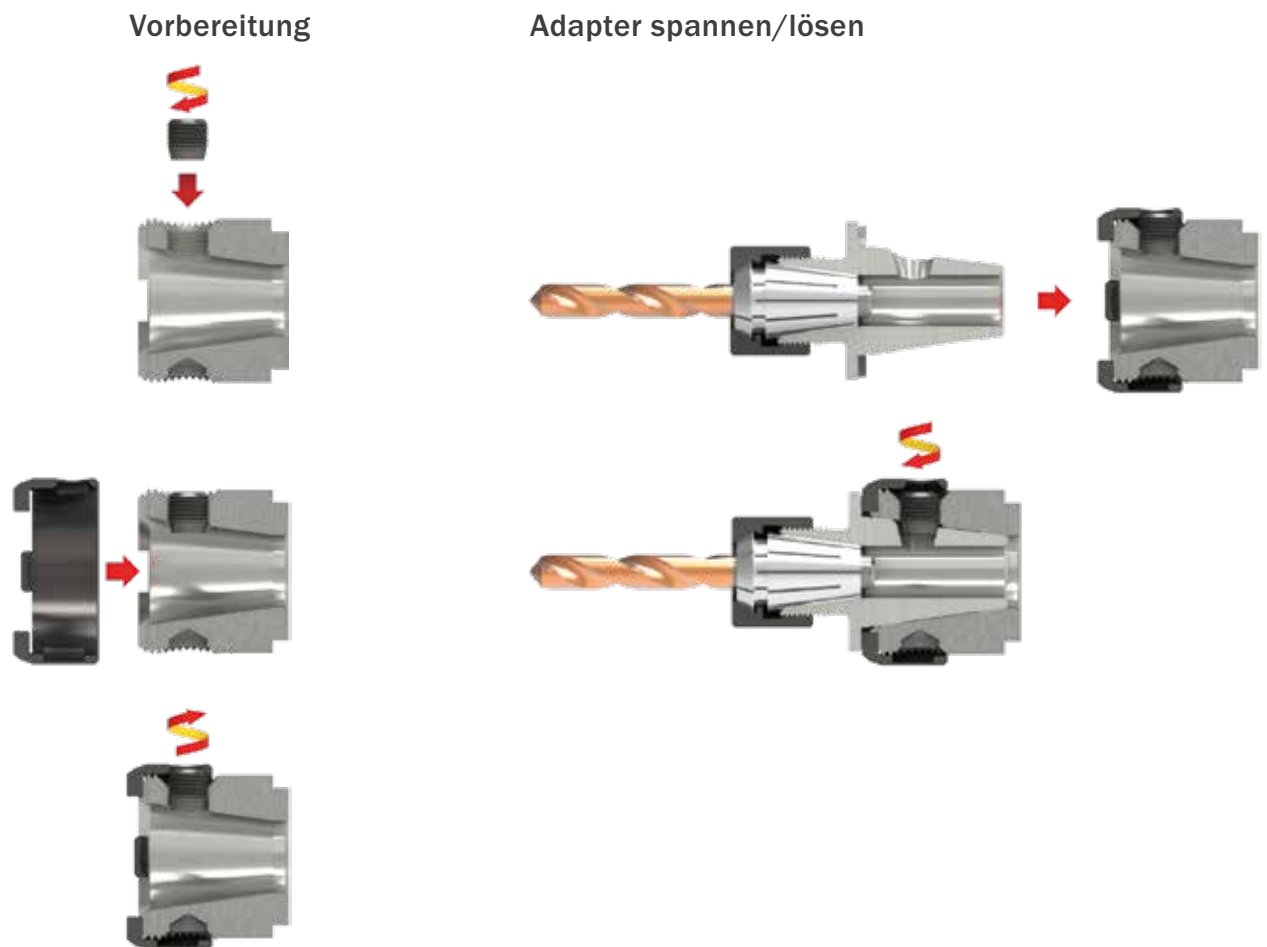

Handling mit Spannzange

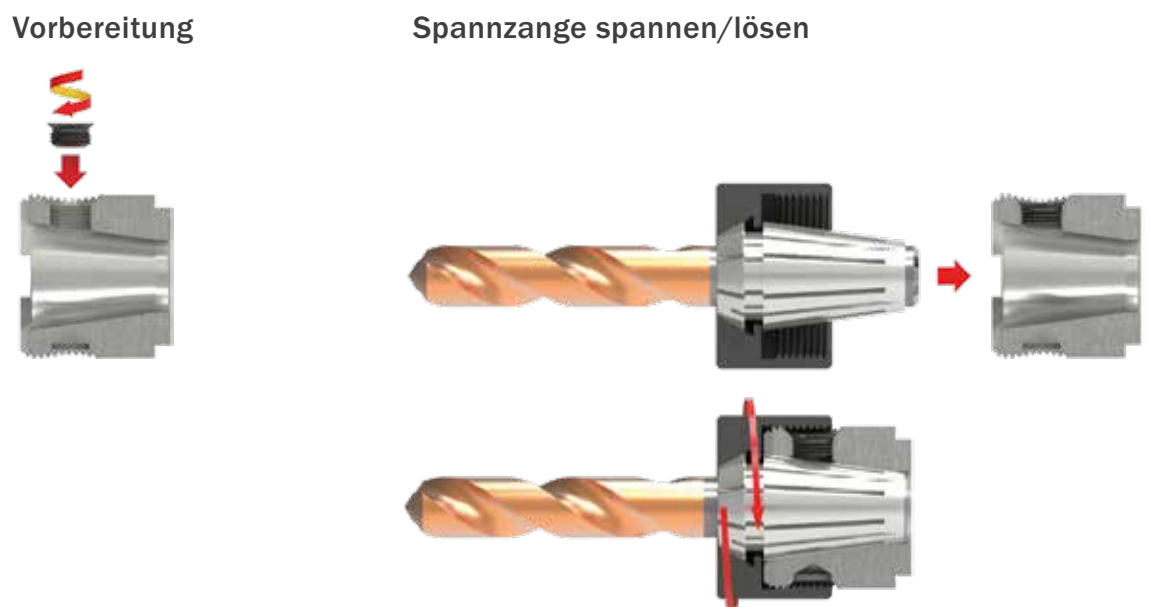



Zylinderschaftaufnahme

mit zylindrischem Schaft und seitlicher Klemmfläche.

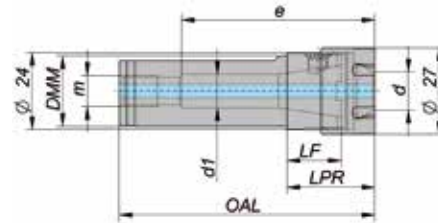
Zum flexiblen Einsatz von ER-Spannzangen und nanoFlex®-Adaptern in Bohrstangen- und Pinolenhaltern.





Größe	Bestellnummer	DMM	d min.	d max.	LF	LPR	OAL	d ₁	m	e			
ER-16NF	NF16-SSH-075-A	¾"	0,5	10	17	28,5	78,5	10,5	G ¹ / ₈ "	60,5	NF16-SCN-A	107520005	NF16-SPLA
ER-16NF	NF16-SSH-022-A	22	0,5	10	17	28,5	80	10,5	G ¹ / ₈ "	60,5	NF16-SCN-A	107520005	NF16-SPLA
ER-16NF	NF16-SSH-025-A	25	0,5	10	17	28,5	78,5	10,5	G ¹ / ₈ "	60,5	NF16-SCN-A	107520005	NF16-SPLA

Abmessungen in mm. Spannmutter und Verschlusschraube ER-16NF enthalten.

Spannzangenadapter

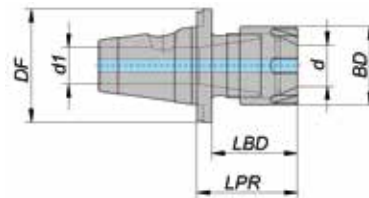
DIN 6499, ISO 15488





Größe	Bestellnummer	DF	d min.	d max.	d ₁	BD	LPR	LBD	Größe Zange		
ER-16NF	NF16-SAD-ER08-A	23	0,5	5	5,5	12	20,5	17,5	ER 8	200508000	107508005
ER-16NF	NF16-SAD-ER11-A	23	0,5	7	7,5	16	20,5	17,5	ER 11	200511000	107511005

Abmessungen in mm

Weldon-/WhistleNotch-Adapter

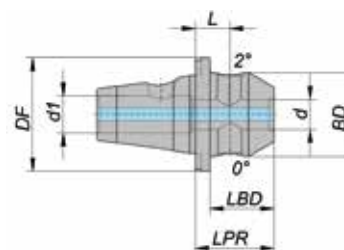
Für Schäfte nach DIN 6535-HB und -HE



Größe	Bestellnummer	DF	d	BD	LPR	LBD	L	d ₁		
ER-16NF	NF16-SAD-WW06-A	23	6	17	16	13	7	7,5	12882	26071

Abmessungen in mm

Prüfdorn/Voreinstell-Adapter

Istmaße eingraviert

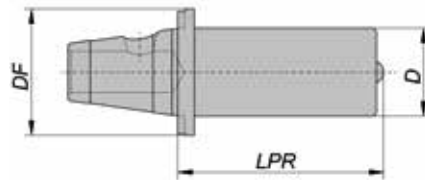





Größe	Bestellnummer	DF	D	LPR
ER-16NF	NF16-SMA-A	23	16	37,5

Abmessungen in mm

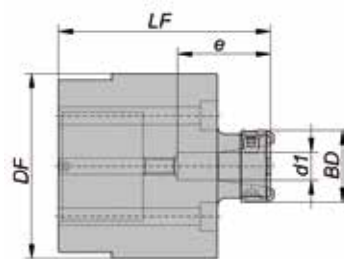
Montage- und Voreinstellblock nanoFlex®

für Werkzeugwechsel und Voreinstellen von nanoFlex®-Adapttern



Größe	Bestellnummer	DF	BD	LF	d ₁	e				
ER-16NF	NF16-SMD-A	70	27	80	10,5	35	NF16-STW-A	NF16-SDR-A	NF16-SCS-A	29205



Abmessungen in mm

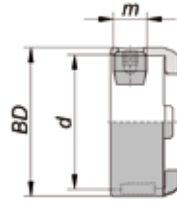

Mitnehmerring

für den Einsatz von nanoFlex®-Adaptern



Größe	Bestellnummer	BD	d	m			
ER-16NF	NF16-SDR-A	27	24	M6x0,5	10IP	NF16-SCS-A	NF16-STW-A



Abmessungen in mm. Inklusive Spannschraube

Drehmomentschraubendreher

zum Spannen der nanoFlex®-Adapter
(Einhandbedienung)



Hinweis:
Klinge wechselbar.



Größe	Bestellnummer		Nm	
ER-16NF	NF16-STW-A	10IP	2,5	109330

Abmessungen in mm

Spannschraube ERNF

zum Spannen der nanoFlex®-Adapter





Größe	Bestellnummer		Nm	
ER-16NF	NF16-SCS-A	10IP	2,5	NF16-STW-A

Abmessungen in mm

Spannmutter ERNF

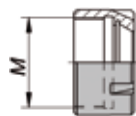
passend für Spannzangenspindelaufnahme
nanoFlex®, DIN 6499, ISO 15488





Größe	Bestellnummer	M	Nm	
ER-16NF	NF16-SCN-A	M24x1	45	107520005

Abmessungen in mm

Verschlusschraube ERNF

zum Verschließen der Spannschraubenbohrung



Größe	Bestellnummer		Nm	
ER-16NF	NF16-SPL-A	10IP	2,5	NF16-STW-A

Abmessungen in mm

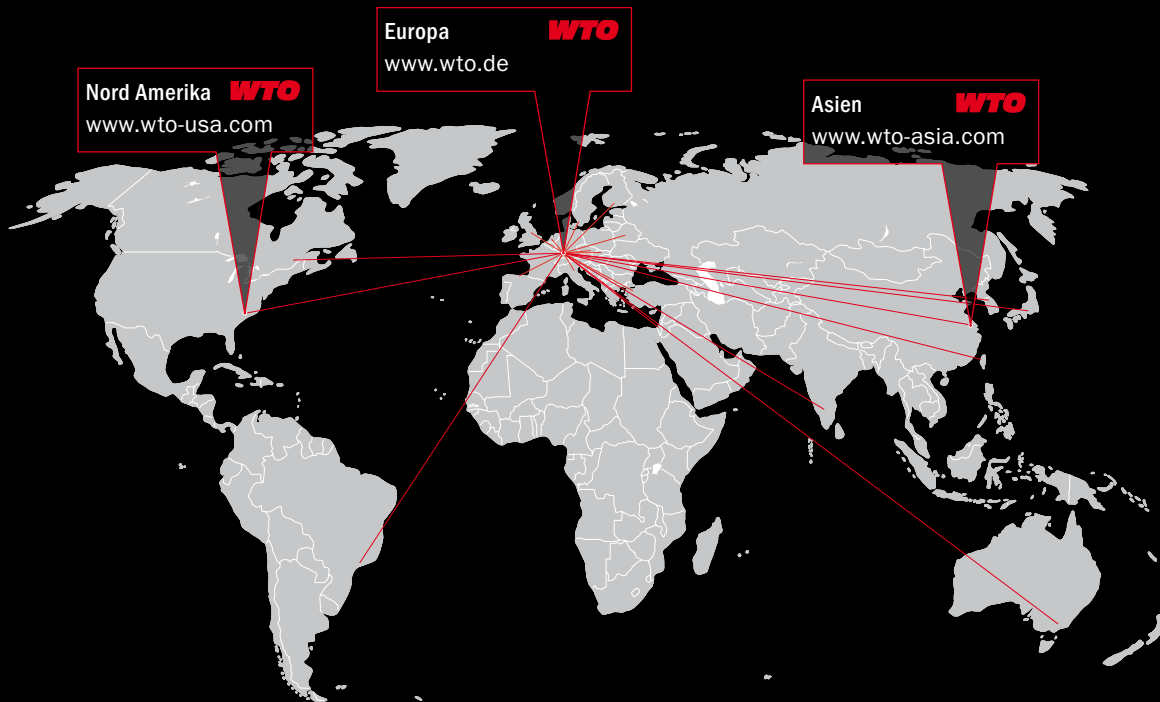

WTO Werkzeug-
Einrichtungen GmbH
Neuer Hohdammweg 1
77797 Ohlsbach
Deutschland

WTO Inc.
13900-F South Lakes Dr.
Charlotte, NC 28273
USA

WTO Asia
WTO Precision Tool Holders
(Shanghai) Co. Ltd.
Room 109-110, Building 2
No. 228 Banting Road
Jiuting Town,
Songjiang District
201615 Shanghai
China

Vertriebspartner – Kompetente Beratung vor Ort

Australien
Dimac Tooling Ltd.
sales@dimac.com.au

Großbritannien
Cutwel Ltd.
sales@cutwel.net

Mexiko
Workholding Engineering De México
info@wem.com.mx

Slowakei
ALBA precision s.r.o.
albabprecision@albabprecision.sk

Brasilien
TF2
tfdois@tfdois.com.br

Indien
Ulhas Patil
u.patil@wto-asia.com

Niederlande
Toologic BeNeLux B.V.
info@toologic-benelux.nl

Spanien
ITALMATIC, S.A.
italmatic@italmatic.es

China
Shanghai Gangde
wtocando@yahoo.com

Israel
E.Y.A.R. Ltd.
boris@eyar.co.il

Norwegen
Helge Karlsen Verktøy og Maskin AS
hkvm@hkvm.no

Taiwan
Kaiko Co., Ltd.
info@kaiko.com.tw

Dänemark
AVN Teknik A/S
cjo@avn.dk

Italien
Prymark srl
commerciale@prymark.it

Polen
ARCO Andrzej Rudenko
info@arcotools.pl

Türkei
MYK CNC MAKINA SAN. VE
huseyin.tatlidil@mykcnc.com.tr

Finnland
Suomen Terästuonti Oy
myynti@stt.as

Japan
NK Works Co. Ltd.
k_samba@nk-works.co.jp

Rumänien
SC Elif Trading SRL
bulent.ozkan@eliftrading.com

Tschechien
ALBA precision, spol. s.r.o.
info@albabprecision.cz

Frankreich Ost
Christophe Archambault
alm@wto.de

Kanada
Mittmann Industrial Inc.
info@mittmann.com

Schweden
Bonhron & Ewing AB
info@bonhron-ewing.se

Ukraine
„LLC“ SPA Stankopromimport
info@phoenix-ua.com

Frankreich West
Christophe Archambault
car@wto.de

Korea
WTO Office Korea
is.chon@wto-korea.com

Schweiz
Utilis AG
info@utilis.com

Ungarn
Prevotex Hungary Kft.
info@prevotex.hu